



Main Features

- Ranges: from 0...3 to 0...500 bar and ranges from -1...+1 to -1...+10 bar
- Output signal 4...20mA 2-wires / 0.1...5.1Vdc / 0.1...10.1Vdc / 0...5Vdc / 0...10Vdc / 1...5Vdc / 1...10Vdc
- Protection rating: IP65/IP67
- Wetted parts AISI 430F and 17-4PH
- Available with a variety of process connections, both standard and custom

TK transmitters are based on the extensimetric thick film measuring principle. Thanks to highly stable electronic components, these transmitters can be used in applications requiring long-distance signal transmission or in smart control systems. TK pressure transmitters are designed mainly to measure pressure in oil, air, and hydraulic circuits. They can also be used in the technical and process measurement application as well as for compressors, presses and mobile hydraulic.

TECHNICAL DATA

	VOLTAGE	CURRENT
Output signal Accuracy (1)	H \pm 0.25% FSO typical (\pm 0.3% FSO max) M \pm 0.5% FSO typical (\pm 0.6% FSO max)	
Measurement range	from 0...3 bar to 0...500 bar; from -1...+1 bar to -1...+10bar	
Resolution	Infinite	
Overpressure (without degrading performance) (2)	See table	
Pressure containment (burst test) (3)	See table	
Pressure Media	Fluid compatible with Inox 17-4 PH/AISI 430F	
Body materials	Inox AISI 304, nylon 66F35VO	
Power supply	B/M/P/R 10...30Vdc C/N/Q 15...30Vdc	10...30Vdc
Supply Sensitivity	< 0.0015% FSO/V	
Output noise (RMS 10-400Hz)	< 0.05% FSO	
Insulation resistance	> 1000 M Ω @ 50Vdc	
Zero output signal	B, C, M, N, P, Q, R	4mA (E)
Full scale output signal	B, C, M, N, P, Q, R	20mA (E)
Max current absorption	13mA	32mA
Max allowed load	1mA	See diagram
Long term stability	< 0.2% FSO/per year	
Operating temperature range (process)	-40...+105°C (-40...+221°F)	
Compensated temperature range	-10...+85°C (+14...+185°F)	
Storage temperature range	-40...+125°C (-40...+257°F)	
Temperature effects over compensated range (zero-span)	\pm 0.012% FSO/°C typical (\pm 0.02% FSO/°C max.)	
Response time (10...90%FSO)	< 1 msec.	
Start-up time	< 500 msec.	
Mounting position effects	Negligible	
Humidity	Up to 100%RH non-condensing	
Weight	110 gr. nominal	
Mechanical shock	100g/1ms according to IEC 68-2-6	
Vibrations	20g max at 15-2000Hz according to IEC 68-2-6	
Ingress protection	sealed to IP65/IP66/IP67	
Output short circuit and reverse polarity protection	YES	

FSO = Full Scale Output

1 BFSL method (Best Fit Straight Line): includes combined effects of Non-Linearity, Hysteresis and Repeatability

2 tested for more than 1000 strokes with single duration < 2msec.

3 tested for more than 100 strokes with single duration < 2msec.

MEASUR. RANGE (Bar)	-1/+1	-1/+2	-1/+3	-1/+5	-1/+10	3	4	5	6	7	10	16	20	25	30	40	50	60	100	160	200	250	350	400	500
Overpressure	2	4	6	10	20	6	8	10	12	14	20	32	40	50	60	80	100	120	200	320	400	500	700	800	1000
Burst test	12	12	12	20	40	12	16	20	24	28	40	64	80	100	120	160	200	240	400	640	800	1000	1200	1200	1200

INSTALLATION DRAWINGS

Dimensions: mm [inches]

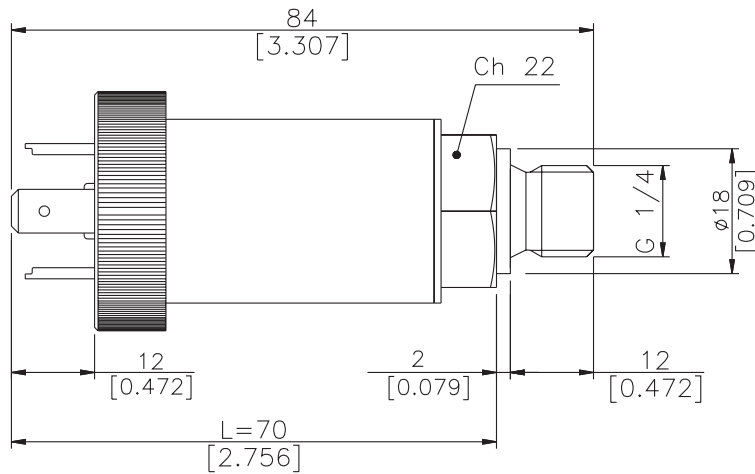

PRESSURE CONNECTION

(1) G 1/4 MALE (DIN 3852-A)

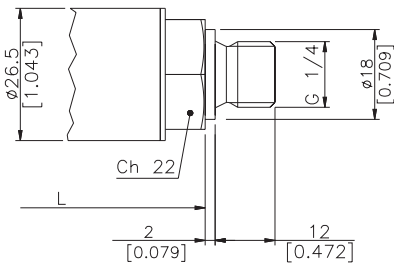

(2) SAE 04 AS4395 - E

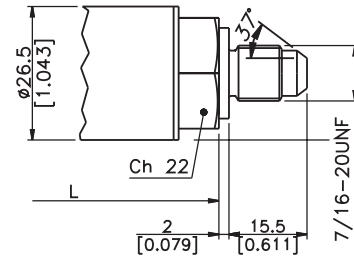

(3) G 1/2 A (DIN 16288)

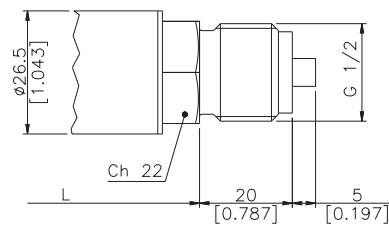

(4) G 1/4 FEMALE

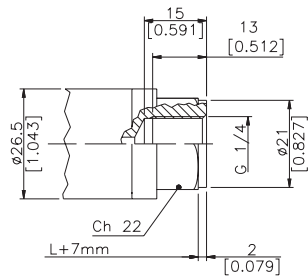

ELECTRICAL CONNECTION

P - 7 pole connector

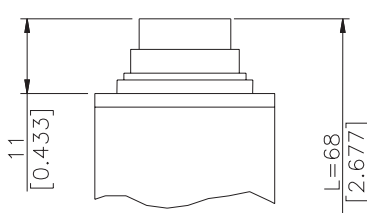

V - 6 pole connector

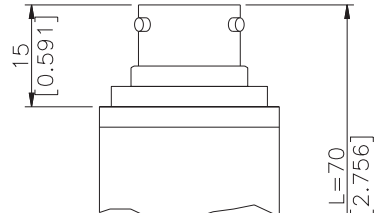

F - 4 pole cable

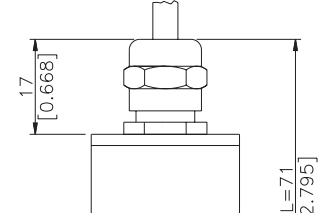

Z - 4 pole connector
M12 x 1

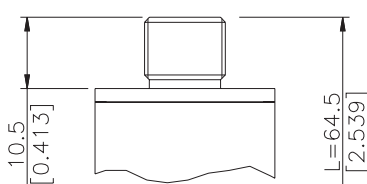

E - 4 pole connector
solenoid

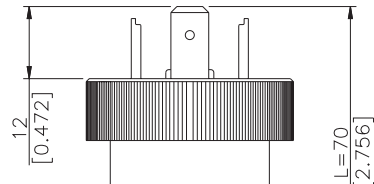

M - 4 pole connector
microsolenoid

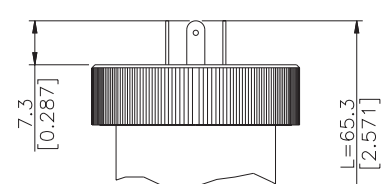

ELECTRICAL CONNECTION - Connectors

P - 7-pole connector

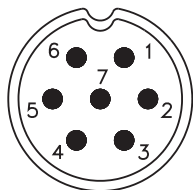

Male connector 09-127-09-07
Protection IP67

V - 6-pole connector

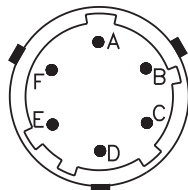

Male connector VPT02A10-6PT2
Protection IP66

F - 2 pole cable

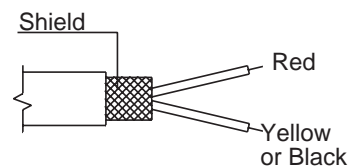

Shielded cable 2x0.25 - 2m. (output E)
Protection IP65

Z - 4-pole male connector M12 x 1

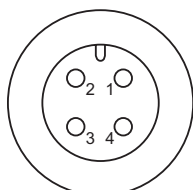

4 pole series 713 male connector
Protection IP67

E - 4 pole solenoid connector M - 4 pole microsolenoid connector

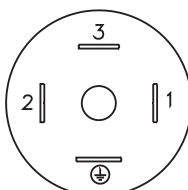

Solenoid DIN 43650A - ISO4400
Protection IP65
Microsolenoid DIN 43650C - ISO4400
Protection IP65

F - 4 pole cable

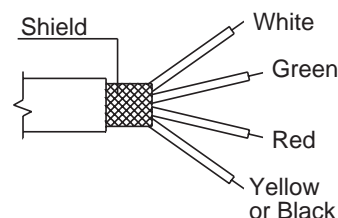

Shielded cable 4x0.25 - 2m
Protection IP65

ELECTRICAL CONNECTION - connection diagrams

VOLTAGE AMPLIFIED OUTPUT - mod. B/C/M/N/P/Q/R

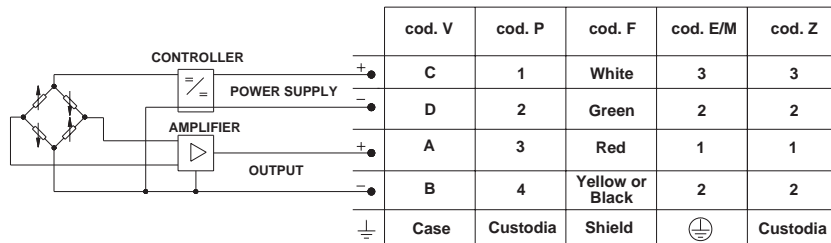

CURRENT AMPLIFIED OUTPUT - mod. E

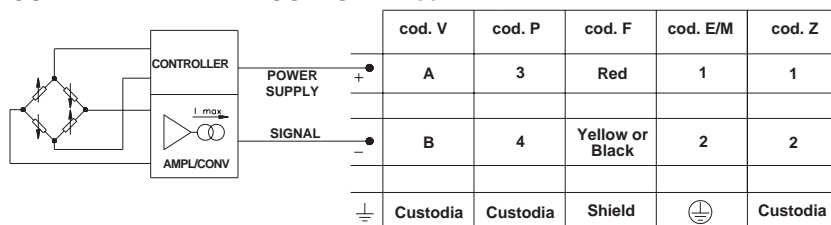

LOAD DIAGRAM (Current output)

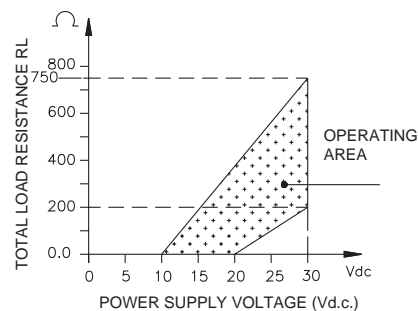

ACCESSORIES ON REQUEST

Connectors Plugs

Connection E

3 poles connector + ground DIN43650A ISO4400 **CON 006**
Prot. IP65

Connection Z

4 poles connector **CON 293**
Prot. IP67

Connection M

3 poles connector + ground DIN43650C ISO4400 **CON 008**
Prot. IP65

Connection P

7 poles female cable connector Prot. IP67 **CON 321**

Connection V

6 poles female cable connector Prot. IP66 **CON 300**

EXTENSION CABLES

6-pin connector with 8m (25ft) cable

C08WLS

6-pin connector with 15m (50ft) cable

C15WLS

6-pin connector with 30m (100ft) cable

C30WLS

Other lengths

consult factory

Cable color code

Conn.	wire
A	Red
B	Yellow/Black
C	White
D	Green
E	Blue
F	Orange

ORDERING INFORMATION

Pressure transmitter

TK

OUTPUT SIGNAL	
Standard	
0,1 ... 10,1 Vdc	C
4...20 mA	E
0...10 Vdc	N
On request	
0,1 ... 5,1 Vdc	B
0 ... 5 Vdc	M
1 ... 5 Vdc	P
1 ... 10 Vdc	Q
1 ... 6 Vdc	R

PRESSURE CONNECTION	
Standard	
G 1/4 gas male (DIN 3852-A)	1
7/16-20 UNF-2A male (SAE 4 for AS4395-E)	2
G 1/2A (DIN 16288)	3
On request	
G 1/4 gas female	4
1/8-27 NPT female	5
1/4 - 18 NPT female	6
1/4 - 18 NPT male	7
M14 x 1.5 male	8
1/8 - 27 NPT male	9
G 1/4 gas male (DIN 3852-E)	E
M12 x 1.5 male	R
7/16-20 UNF-2A male (SAE 4 for J1926-2) (*)	K
7/16-20 UNF-2A female (SAE 4)	F

(*) Max. working pressure:
630 bar (9137 psi)

ELECTRICAL CONNECTION	
Standard	
4-pole connector solenoid	E
Shielded cable	F
4 pole connector M12 x 1	Z
On request	
4-pole connector microsolenoid	M
7 pole connector	P
6 pole connector	V

Mechanical and/or electrical characteristics differing from standard may be arranged on request.

RESPONSE TIME

V Fast (< 1 msec)

ACCURACY

H ± 0.25% FSO Typical

M ± 0.5% FSO Typical

MEASUREMENT RANGE

bar		bar		psi	
N01U	-1..+1 *	B25U	0..25	V15U	-15..+15 *
N02U	-1..+2 *	B03D	0..30	V03D	-15..+30 *
N03U	-1..+3 *	B04D	0..40	V05D	-15..+50 *
N05U	-1..+5	B05D	0..50	V75U	-15..+75
N01D	-1..+10	B06D	0..60	V01C	-15..+100
B03U	0..3	B01C	0..100	P05D	0..50
B04U	0..4	B16D	0..160	P75U	0..75
B05U	0..5	B02C	0..200	P01C	0..100
B06U	0..6	B25D	0..250	P15D	0..150
B07U	0..7	B35D	0..350	P25D	0..250
B01D	0..10	B04C	0..400	P03C	0..300
B16U	0..16	B05C	0..500	P05C	0..500
B02D	0..20			P75D	0..750
* only M class					
				P01M	0..1000
				P15C	0..1500
				P25C	0..2500
				P03M	0..3000
				P05M	0..5000
				P75C	0..7500

CALIBRATION STANDARDS

Instruments manufactured by Gefran are calibrated against precision pressure calibration equipment which is traceable to International Standards.

Es: TK - E - 1 - E - B04C - H - V

Pressure transmitter TK with 4 to 20 mA output signal, G1/4 male pressure connection, DIN 43650A electrical connector, 0...400 bar pressure range, ± 0.25% FSO accuracy, 1 msec response time

Sensors are manufactured in compliance with:

- EMC 2004/108/CE compatibility directive
- RoHS 2002/95/CE directive

Electrical installation requirements and Conformity certificate are available on our web site: www.gefran.com

GEFRAN spa reserves the right to make any kind of design or functional modification at any moment without prior notice

GEFRAN spa

via Sebina, 74

25050 PROVAGLIO D'ISEO (BS) - ITALIA

tel. 0309888.1 - fax. 0309839063

Internet: <http://www.gefran.com>

GEFRAN

DTS_TK_0709_ENG